

GRU A TORRE

GA 132H

GRU AUTOMATICA CON
MONTAGGIO IDRAULICO

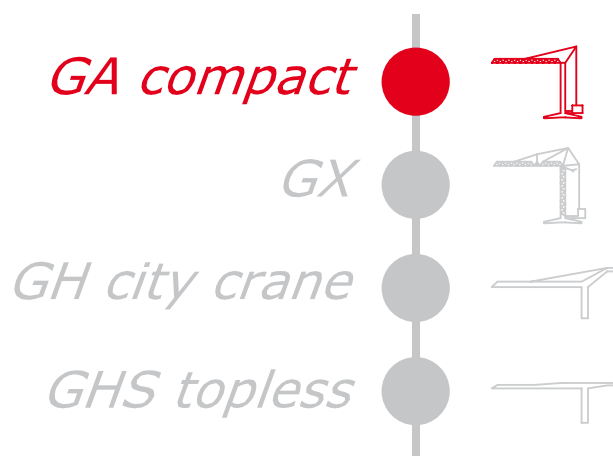

FB F.lli Butti s.r.l.

Via XXV Aprile, 58
23868 Valmadrera (LC) - ITALIA
Tel. 0341.581108 - Fax 0341.200253
E-mail : fbgru@fbgru.it - <http://www.fbgru.it>



FEM 1.001 - A3
EN 14439 - C25

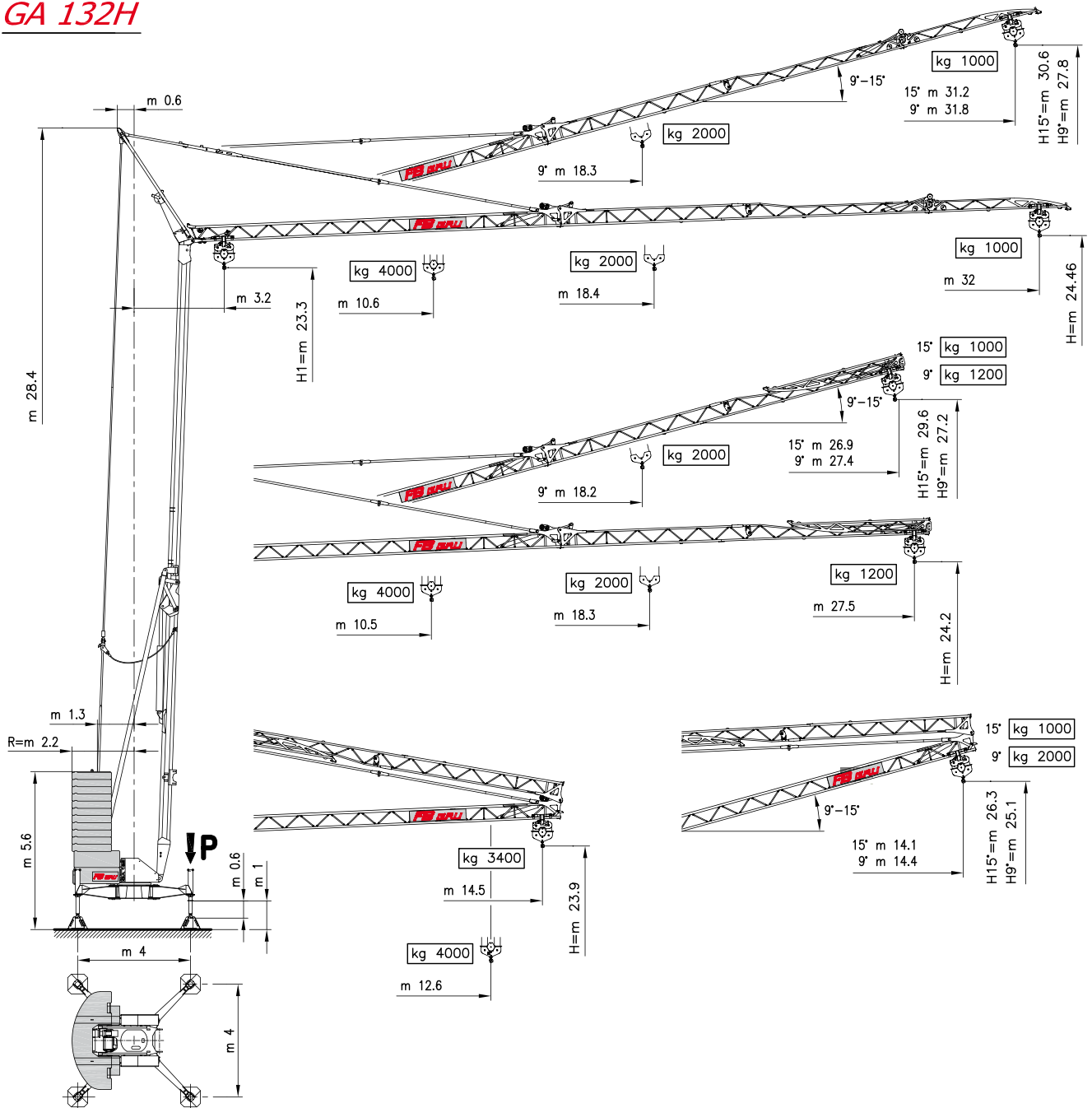

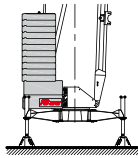
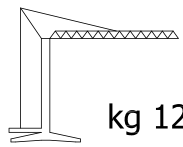

P	
kg 24600 <i>In servizio</i> En servicio In service In betrieb En service	kg 21700 <i>Fuori servizio</i> Fuera de servicio Out of service Außer betrieb Hors service

	
	N° 11x1800 N° 2x1700 N° 2x1920 kg 27040
	kg 12580

LA GRU LA GRUA — CRANE
KLAN — GRUE



MOVIMENTO MOVIMIENTO MOVEMENT BEWEGUNG MOUVEMENT	ALIMENTAZIONE ALIMENTACION OPERATING VOLTAGE BETRIEBSSPANNUNG TENSION DE SERVICE	PRESTAZIONI FUNCIONAMIENTOS PERFORMANCES LEISTUNGEN EXÉCUTIONS	
---	---	---	---

SOLLEVAMENTO ELEVACION — HOISTING HEBEN — LEVAGE INVERTER		400 V 50 Hz		1 ^a m/1' - kg	2 ^a m/1' - kg	3 ^a m/1' - kg	4 ^a m/1' - kg	kW 9.2
				5 ↓ ↑	24 ↑ 26 ↓	38 ↑ 40 ↓	45 ↑ 48 ↓	
				2000	2000	1000	600	
				3 ↓ ↑	12 ↑ 13 ↓	19 ↑ 20 ↓	23 ↑ 24 ↓	
				4000	4000	2000	1200	

CARRELLO CARRILLO — JIB TROLLEY LAUFKATZE — DISTRIBUTION INVERTER		400 V 50 Hz	1 ^a m/1'	2 ^a m/1'	3 ^a m/1'	kW 3
			19	42	61	

ROTAZIONE ROTACION — SLEWING DREHEN — ORIENTATION INVERTER		400 V 50 Hz	1 ^a g/1'	2 ^a g/1'	3 ^a g/1'	kW 3
			0 → 0.15	0.15 → 0.45	0.45 → 0.89	



Conforme alle direttive
CEE sul livello acustico
 2000/14/CE

Conforme con las directivas
 CEE sobre el nivel acustico

In compliance with the EEC
 instructions on noise level

Gemass EWG-Richtlinien für
 den Schall-Leistungspegel

Conforme aux directives CEE
 sur le niveau acoustique

CURVE DI CARICO



CURVAS DE CARGAS — LOAD DIAGRAMS

LASTKURVEN — COURBES DE CHARGES

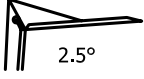
V32 

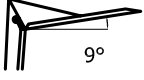
 2.5°	m	10.6	12	14	16	17	18.4	20	22	24	26	28	30	32
	kg	4000	3413	2803	2369	2195	2000	1808	1606	1440	1303	1186	1086	1000

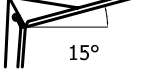

 9°	m	3	5	10	15	17	18.3	20	22	24	26	28	30	31.8
	kg							2000	1795	1594	1429	1293	1177	1078

 15°	m	3	5	10	15	20	25	30	31.2	(0 - 2000 kg)		(2001 - 4000 kg)	
	kg									1000			

POTENZA RICHIESTA

POTENCIA-ELECTRICA NECESARIA — NECESSARY ELECTRIC POWER

KRAFTBEDARF — PUISSANCE ELECTRIQUE NECESSAIRE

	SOLLEVAMENTO ELEVACION — HOISTING — HEBEN — LEVAGE	 kg 2000	 kg 4000
	<h1>12 kw</h1> 400 V - 50 Hz		

GA 132H

TRASPORTO TRANSPORTE — TRANSPORT
TRANSPORT — TRANSPORT

5
km/h

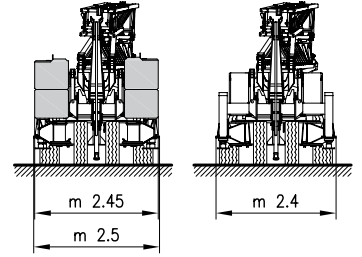
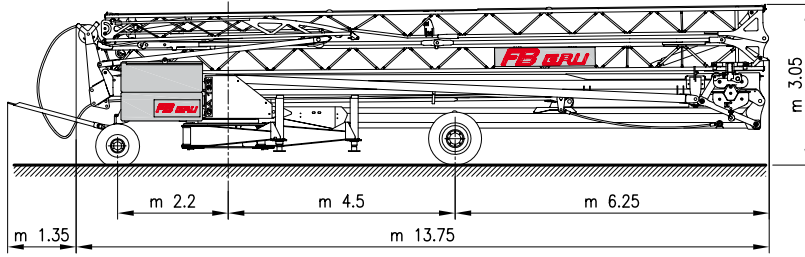

FB25K1

25
km/h

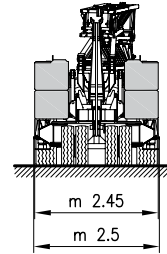
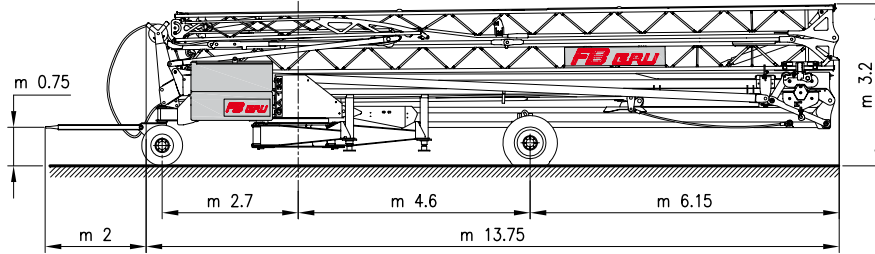

MONTAGGIO MONTAJE — ERECTION
MONTAGE — MONTAGE

